

VM090D (old ref.: VWA 5000090 AA)

• General Description

The VM090D is a Microwave Monolithic Integrated Circuit (MMIC) designed in HEMT (High Electron Mobility Transistor) structure for operating frequency range from 8.5 to 10.5GHz.

The MMIC is developed on 250nm GaN/SiC process and is internally matched through 50Ω RF accesses. It can provide an output power up to 20W and associated power added efficiency of 32% in pulsed mode.

• Features

Frequency range	8.5 – 10.5GHz
Output Power	43dBm @Pin = 23dBm
PAE	32% @Pin = 23dBm
Linear Gain	27dB
DC bias	V_D = +28V, I_{DQ} = 190mA, V_G = -2.35V (Typical)
Chip size	5 x 1.7 x 0.1 (mm)

• Applications

- Radar
- Test and Measurement

• Pins Assignment & Functional Block Diagram

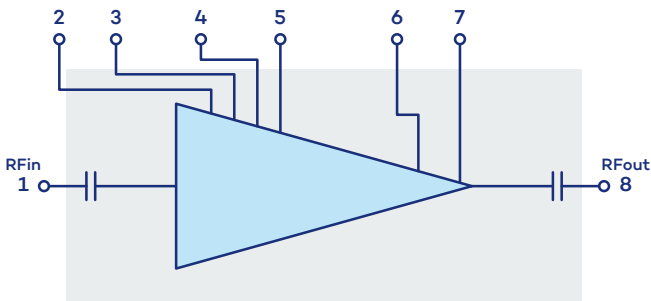

Function	Pin number
RFIn	1
V _{G1}	2
V _{D1}	3
V _{G2}	4
V _{D2}	5
V _{G3}	6
V _{D3}	7
RFout	8

• Electrical Specifications

Test conditions: unless otherwise noted

- $T_{amb} = +25^{\circ}\text{C}$
- $V_D = +28\text{V}$
- $I_{DQ} = 190\text{mA}$ ($V_G = -2.35\text{V Typ.}$)
- Pulsed mode (pulse width: $30\mu\text{s}$, duty cycle: 10%)

Symbol	Parameter	Min	Typ	Max	Unit
F	Frequency range	8.5		10.5	GHz
G	Linear gain		27		dB
S11	Input return loss		-8		dB
S22	Output return loss		-12		dB
P _{out}	Output power (@P _{in} =23dBm)		43		dBm
PAE	Associated Power Added Efficiency (@P _{in} =23dBm)		32		%
I _D	Associated Drain current (@P _{in} =23dBm)		2.4		A
V _D	Drain voltage		28		V

• Recommended Operating Conditions

Symbol	Parameter	Value	Unit
V _D	Drain voltage	28	V
I _{DQ}	Drain quiescent current	190	mA
V _G	Gate voltage	-2.35 (Typ.)	V

• Absolute Maximum Ratings

Symbol	Parameter	Value	Unit
V _D	Drain bias voltage	35	V
I _D	Drain bias current	3	A
V _G	Gate bias voltage	-10 to -2	V
P _{in}	Maximum peak input power overdrive	30	dBm
T _j	Junction temperature	225	°C
T _a	Operating temperature range	-40/+85	°C
T _{stg}	Storage temperature range	-55/+150	°C

Operation of this device above any of these parameters may cause permanent damage.

• **Typical Performance**
(Small signal / Board Measurement)

Test conditions: unless otherwise specified

- Reference plane: connector access
- $V_D = +28V$
- $I_{BQ} = 190mA$ ($V_G = -2.35V$ Typ.)
- $P_{in} = -20dBm$

Gain vs Frequency vs Temperature

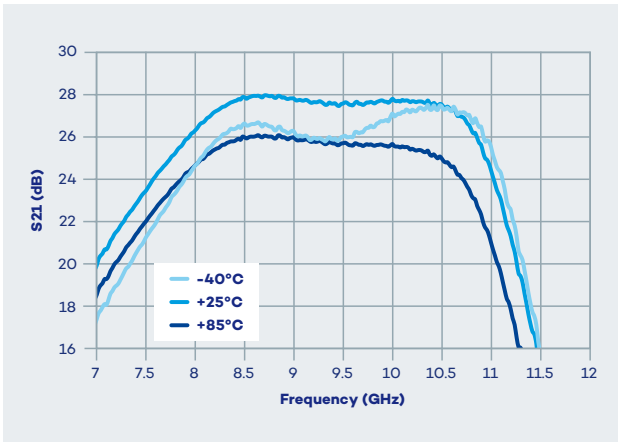

Gain vs Frequency vs V_D

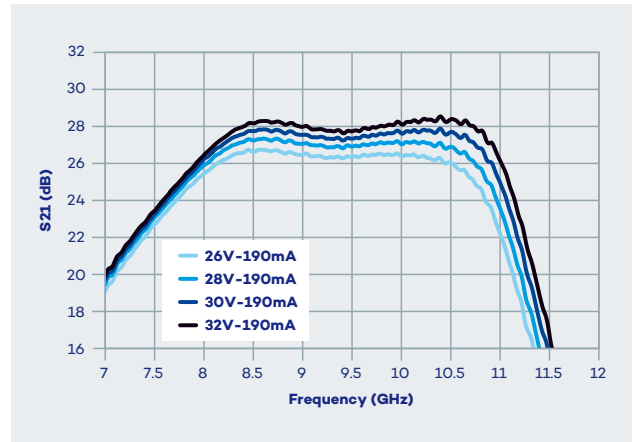

Input Return Loss vs Frequency vs Temperature

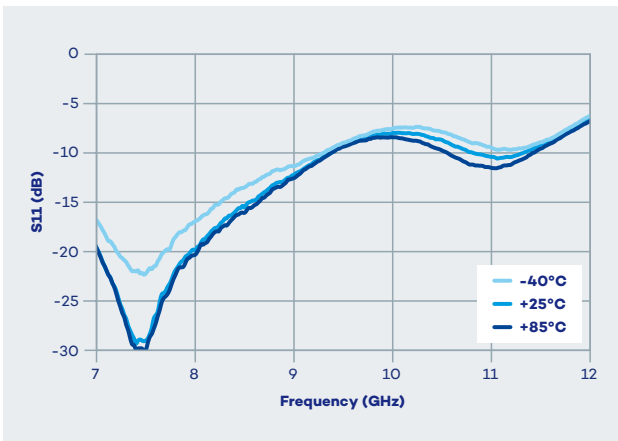

Gain vs Frequency vs I_{BQ}

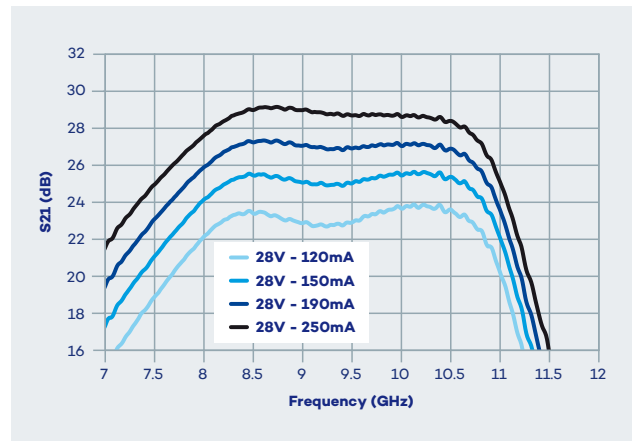

Output Return Loss vs Frequency vs Temperature

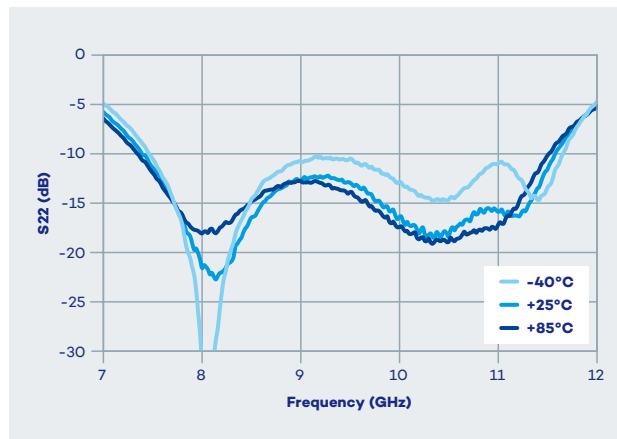

• **Typical Performance**
(Large signal / Board Measurement)

Test conditions: unless otherwise specified

- Reference plane: die access
- $V_D = +28V$
- $I_{BQ} = 190mA$ ($V_G = -2.35V$ Typ.)
- $P_{in} = +23dBm$
- Pulsed mode (pulse width: $30\mu s$, duty cycle: 10%)

Output Power vs Frequency vs Temperature

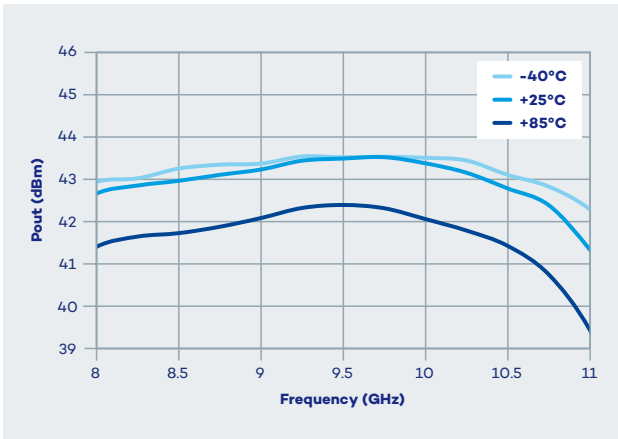

Output Power vs Input Power vs Temperature

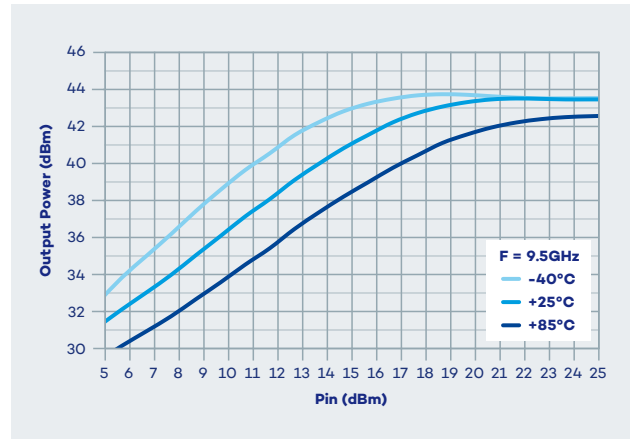

Power Gain vs Frequency vs Temperature

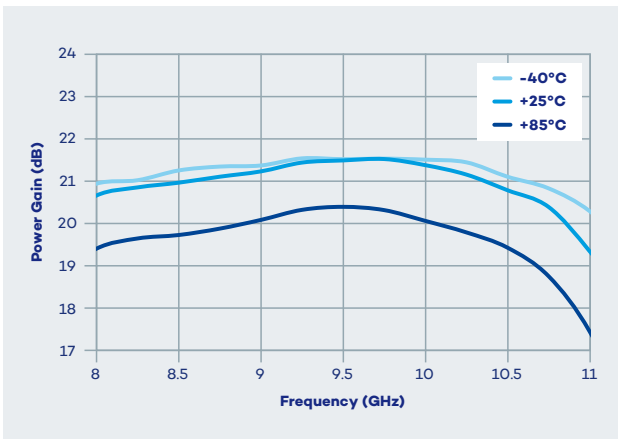

Gain vs Input Power vs Temperature

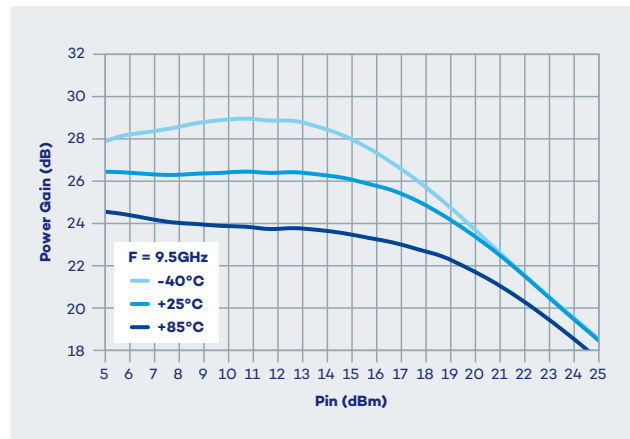

Drain Current vs Frequency vs Temperature

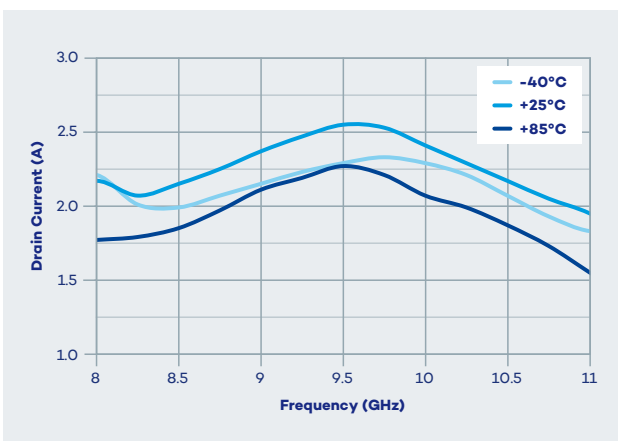

PAE vs Frequency vs Temperature

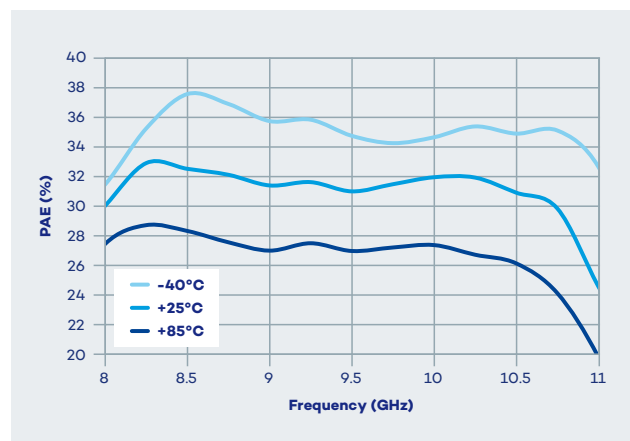

• **Typical Performance**
(Large signal / Board Measurement)

Test conditions: unless otherwise specified

- Reference plane: die access
- $V_D = +28V$
- $I_{DQ} = 190mA$ ($V_G = -2.35V$ Typ.)
- $T_{amb} = +25^\circ C$
- Pulsed mode (pulse width: 30 μs , duty cycle: 10%)

Output Power vs Input Power vs Frequency

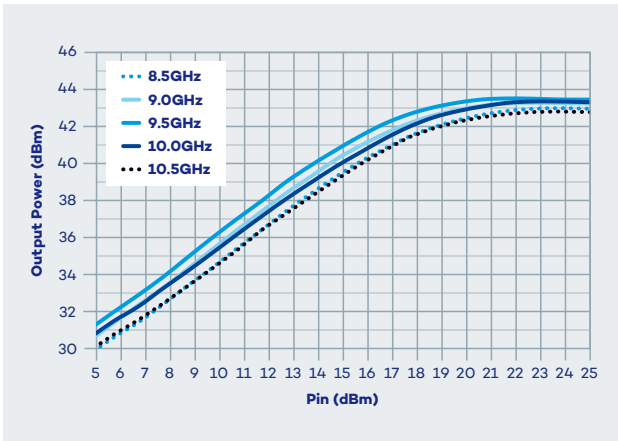

Gain vs Input Power vs Frequency

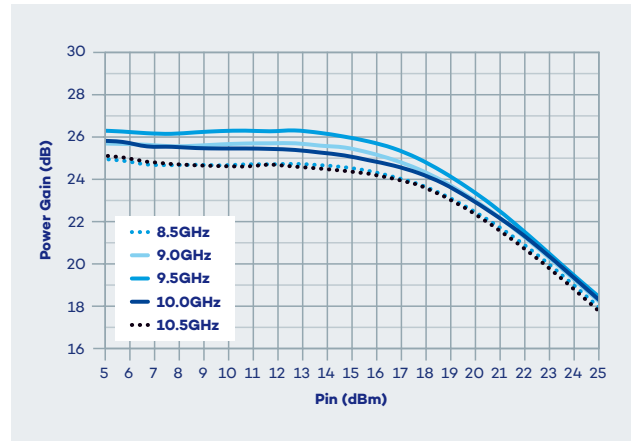

Drain Current vs Input Power vs Frequency

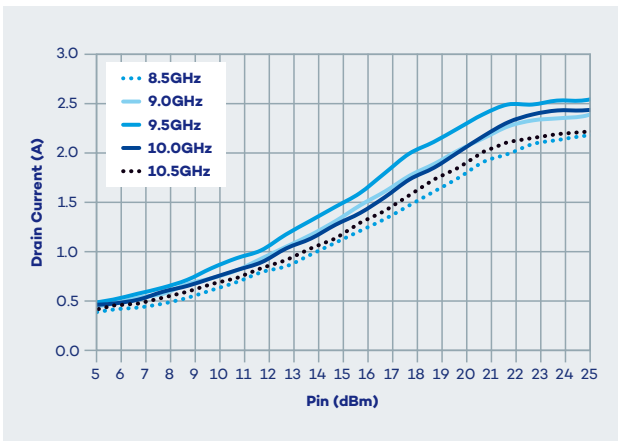

PAE vs Input Power vs Frequency

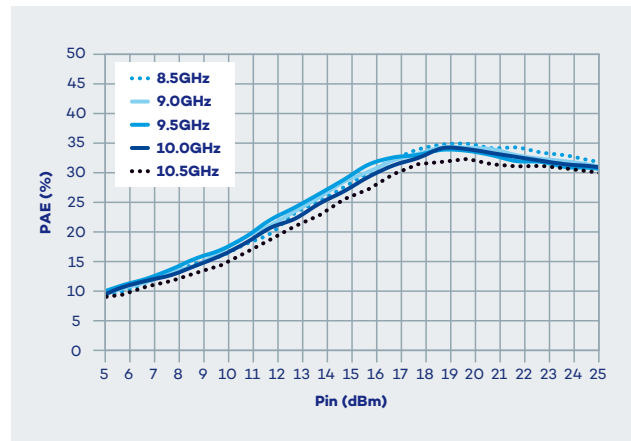

Output Power vs Frequency vs V_D

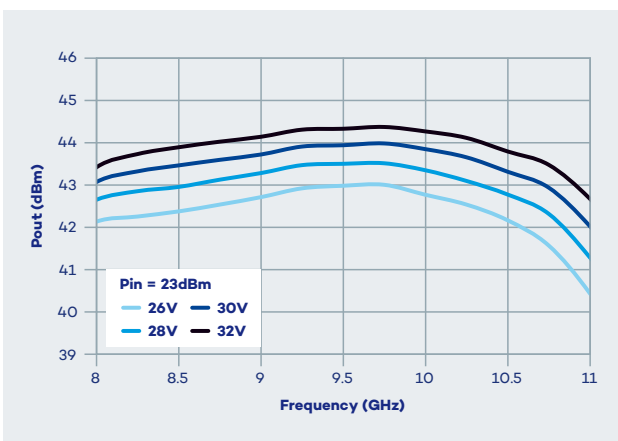

PAE vs Frequency vs V_D

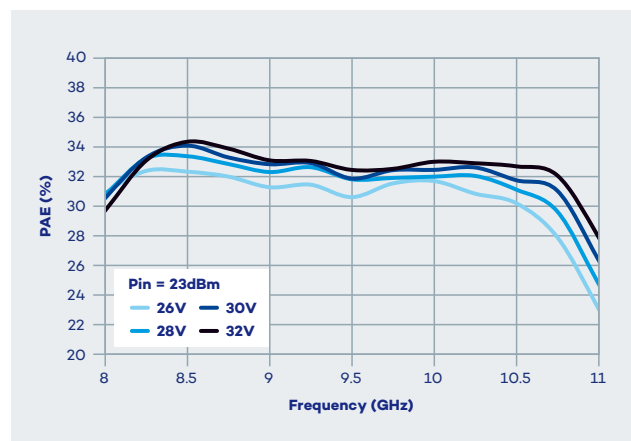

• **Typical Performance**
(Large signal / Board Measurement)

Test conditions: unless otherwise specified

- Reference plane: die access
- $V_D = +28V$
- $T_{amb} = +25^\circ C$
- Pulsed mode (pulse width: 30 μs , duty cycle: 10%)

Output Power vs Input Power vs I_{DQ}

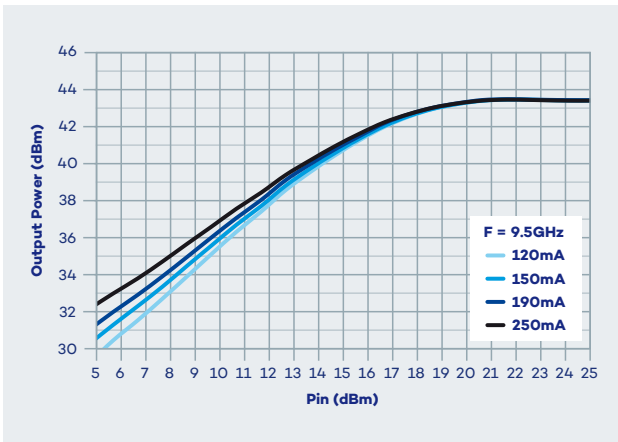

Gain vs Input Power vs I_{DQ}

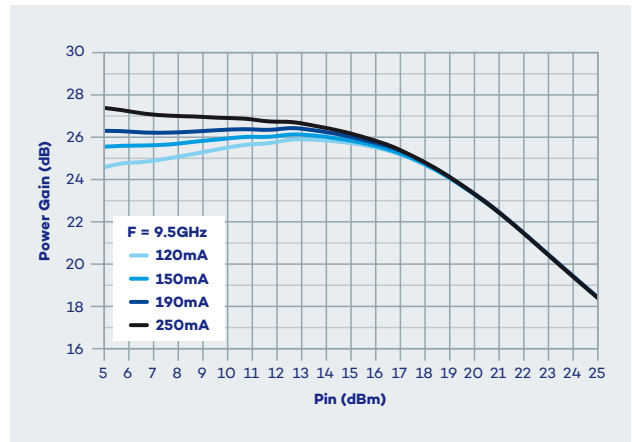

Drain Current vs Input Power vs I_{DQ}

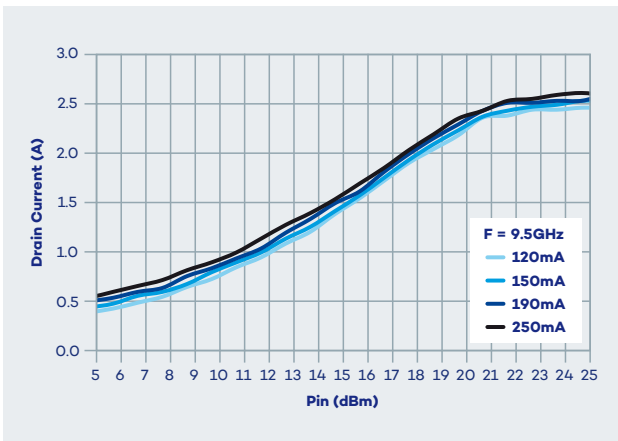

Drain Current vs Frequency vs I_{DQ}

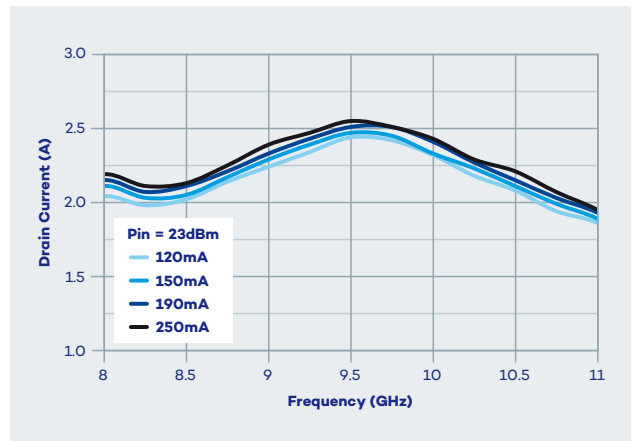

PAE vs Input Power vs I_{DQ}

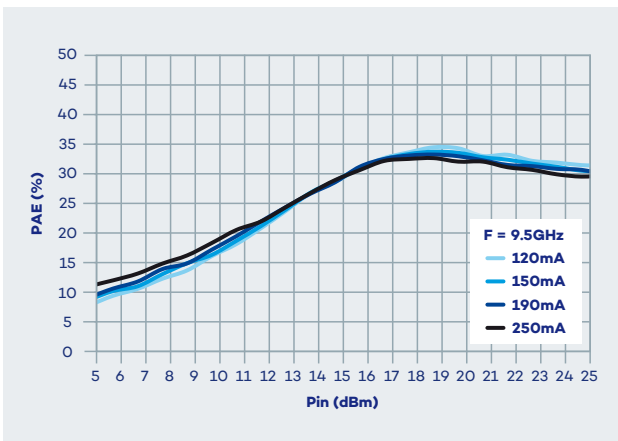

PAE vs Frequency vs I_{DQ}

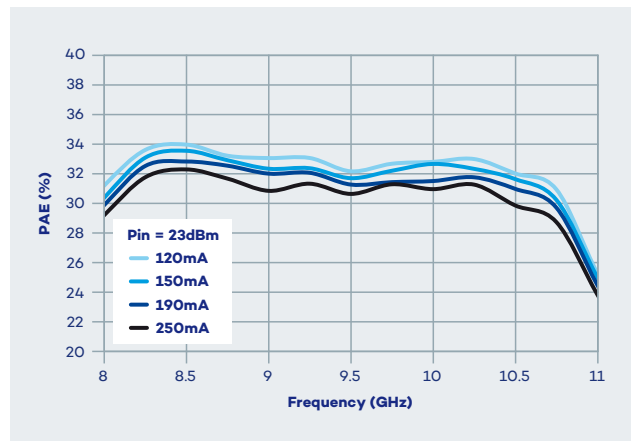

• **Application circuit**

- C1 to C6 = 180pF
- C7 to C9 = 1nF
- C10 = 100μF

- C11 = 1μF
- C1 to C9 should be MIM capacitors

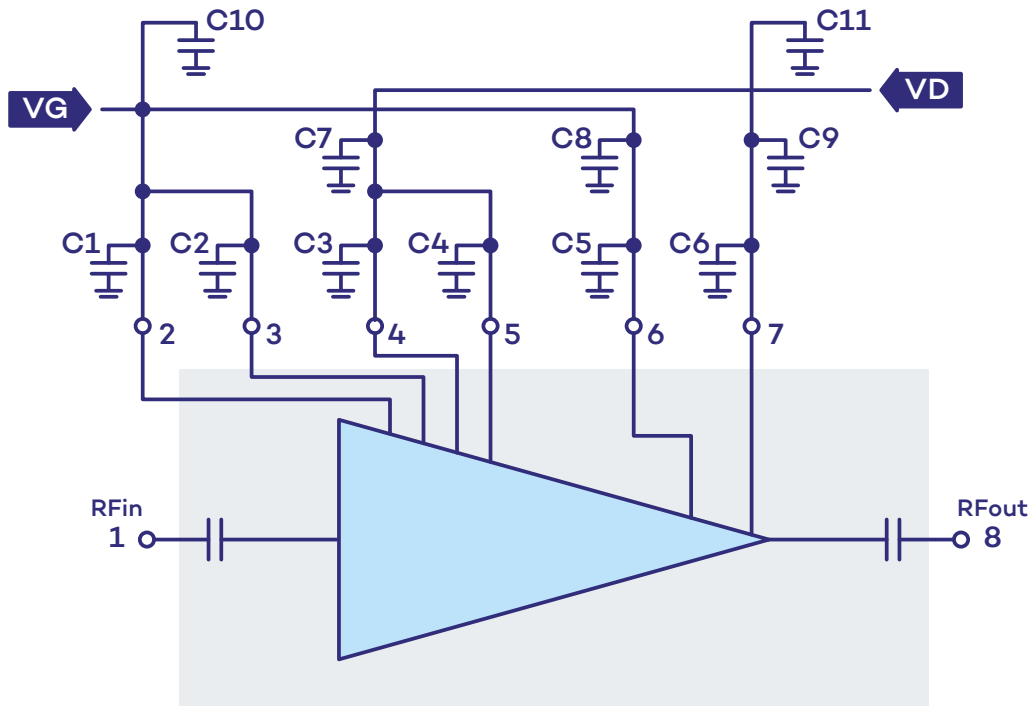

• **Bias-up procedure**

1. Apply $V_G = -3V$
2. Apply $V_D = +28V$
3. Adjust V_G to obtain the specified $I_{DQ} = 190\text{ mA}$ ($V_G = -2.35V$ Typ.)
4. Apply RF signal in pulsed mode

• **Bias-down procedure**

1. Turn off RF signal
2. Reduce $V_G = -3V$
3. Apply $V_D = 0V$
4. Turn off power supply

- Evaluation Board (EVB) Layout Assembly

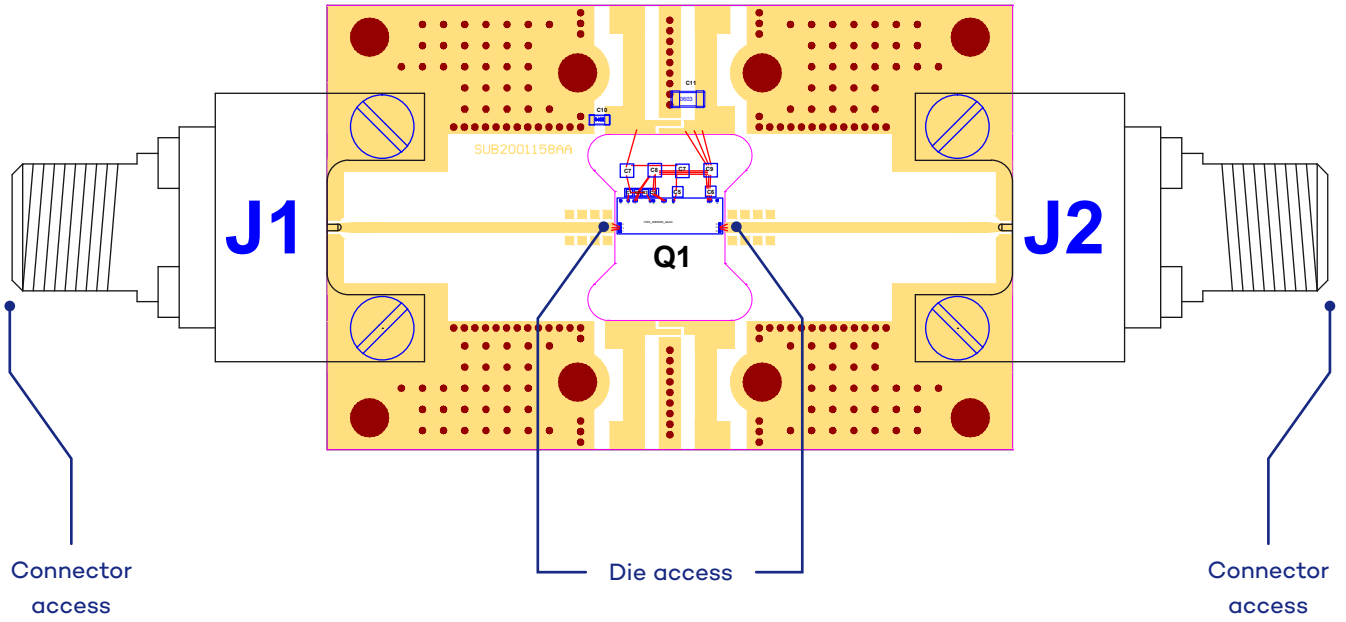

• Die Layout & Pin Out

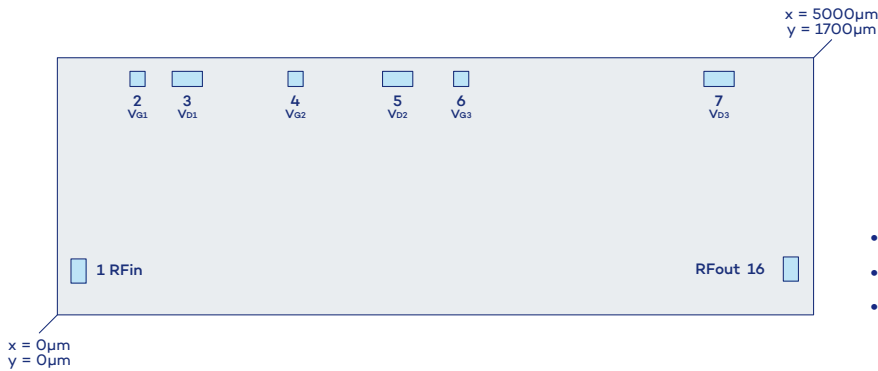

- Die size = 5000µm x 1700µm
- Die thickness = 100µm
- Die size tolerance = 50µm

Pad number	X (µm)	Pad center Y (µm)	Size (µm x µm)	Name	Function
1	140	290	100 x 160	RFin	RF Input
2	530	1560	100 x 100	VG1	Gate Bias
3	859	1560	200 x 100	VD1	Drain Bias
4	1575	1560	100 x 100	VG2	Gate Bias
5	2250	1560	200 x 100	VD2	Drain Bias
6	2670	1560	100 x 100	VG3	Gate Bias
7	4375	1560	200 x 100	VD3	Drain Bias
8	4850	303	100 x 160	RFout	RF Output

- Die bottom must be connected to ground (RF and DC)

• Ordering information

Product Code	Parameter
VM090D	8.5 to 10.5GHz - 20W GaN/SiC Power Amplifier in die form

• Associated Material

- Packaged die
- Die Evaluation Board (die EVB)
- Packaged die Evaluation Board (packaged die EVB)
- Mechanical files (DXF)
- Measurements files (S2P)

• Product Compliance Information

Solderability

Use only AuSn (80/20) solder and limit exposure to temperature above 300 °C during 3-4 minutes, maximum.

ESD Sensitivity Rating

Test: Human Body Model (HBM)
Std: JEDEC Standard JESD22-A114



RoHS-Compliance

This part is compliant with EU 2011/65/EU RoHS directive (Restrictions on the Use of Certain Hazardous Substances in Electrical and Electronic Equipment).

Other attributes

- Lead Free
- Halogen Free (Chlorine, Bromine)
- Antimony Free
- TBBP-A (C15H12Br4O2) Free
- PFOS Free
- SVHC Free

• Contact information

For the latest specifications, additional product information, worldwide sales and distribution locations, and information about Vectrawave.

vectrawave.com

+33 (0)2 57 63 00 20
contact_sales@vectrawave.com

Vectrawave SA

5, rue de Louis de Broglie
22300 Lannion
France

Informations contained in this document, are considered to be accurate and reliable. However, no responsibility is assumed by Vectrawave for the consequence of its use, nor for any infringement of patents or other rights of third parties that may result from this use. Products are not authorized for use in life support devices without prior written approval from Vectrawave. Specifications are subject to change without notice.