

### VM090Q (old ref.: VWA 0001128 AA)

## • General Description

The VM090Q is a packaged power amplifier matched through 50Ω RF accesses. It can provide an output power up to 20W and associated power added efficiency of 30% in pulsed mode.

The VM090Q a plastic 48 leads 7 x 7 QFN designed to a surface mount design board. The VM090Q integrates the VM090D VectraWave HPA.

## • Features

Frequency range	<b>8.5 – 10GHz</b>
Output Power	<b>43dBm @Pin = 23dBm</b>
PAE	<b>30% @Pin = 23dBm</b>
Linear Gain	<b>&gt;26dB</b>
DC bias	<b>V<sub>D</sub> = +28V, I<sub>DQ</sub> = 190mA, V<sub>G</sub> = -2.35V (Typical)</b>
Plastic QFN	<b>7 x 7 (mm) 48leads</b>

## • Applications

- Radar
- Test and Measurement

## • Pins Assignment & Functional Block Diagram

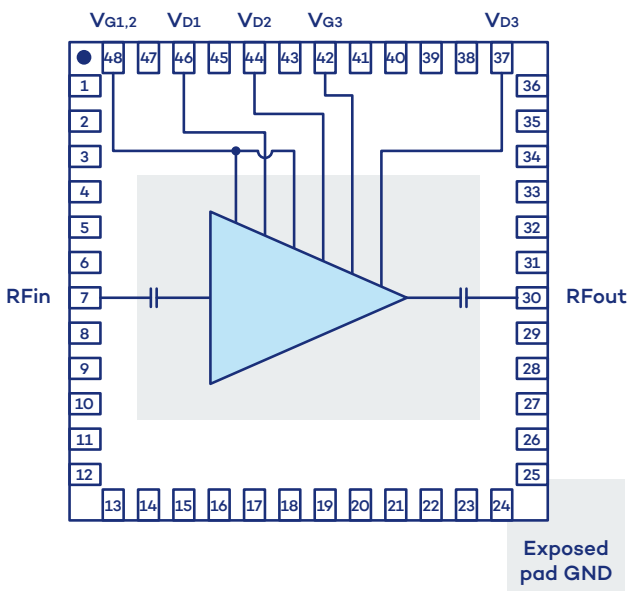

Function	Pin number
NC	1 to 6
RFin	7
NC	8 to 29
RFout	30
NC	31 to 36
V <sub>D3</sub>	37
NC	38 to 41
V <sub>G3</sub>	42
NC	43
V <sub>D2</sub>	44
NC	45
V <sub>D1</sub>	46
NC	47
V <sub>G1,2</sub>	48

## • Electrical Specifications

Test conditions: unless otherwise noted

- $T_{amb} = +25^{\circ}\text{C}$
- $V_D = +28\text{V}$
- $I_{DQ} = 190\text{mA}$  ( $V_G = -2.35\text{V Typ.}$ )
- Pulsed mode (pulse width:  $30\mu\text{s}$ , duty cycle: 10%)

Symbol	Parameter	Min	Typ	Max	Unit
F	Frequency range	8.5		10.0	GHz
G	Linear gain		26		dB
S11	Input return loss		-8		dB
S22	Output return loss		-10		dB
P <sub>out</sub>	Output power (@P <sub>in</sub> =23dBm)		43		dBm
PAE	Associated Power Added Efficiency (@P <sub>in</sub> =23dBm)		30		%
I <sub>D</sub>	Associated Drain current (@P <sub>in</sub> =23dBm)		2.4		A
V <sub>D</sub>	Drain voltage		28		V

## • Recommended Operating Conditions

Symbol	Parameter	Value	Unit
V <sub>D</sub>	Drain voltage	28	V
I <sub>DQ</sub>	Drain quiescent current	190	mA
V <sub>G</sub>	Gate voltage	-2.35 (Typ.)	V

## • Absolute Maximum Ratings

Symbol	Parameter	Value	Unit
V <sub>D</sub>	Drain bias voltage	35	V
I <sub>D</sub>	Drain bias current	3	A
V <sub>G</sub>	Gate bias voltage	-10 to -2	V
P <sub>in</sub>	Maximum peak input power overdrive	30	dBm
T <sub>j</sub>	Junction temperature	225	°C
T <sub>a</sub>	Operating temperature range	-40/+85	°C
T <sub>stg</sub>	Storage temperature range	-55/+150	°C

Operation of this device above any of these parameters may cause permanent damage.

• **Typical Performance**  
(Small signal / Board Measurement)

Test conditions: unless otherwise specified

- Reference plane: connector access
- $V_D = +28V$
- $I_{BQ} = 190mA$  ( $V_G = -2.35V$  Typ.)
- $P_{in} = -20dBm$

**Gain vs Frequency vs Temperature**

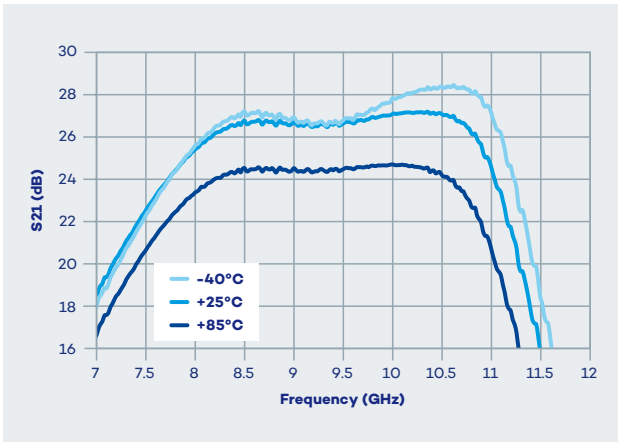

**Gain vs Frequency vs  $V_D$**

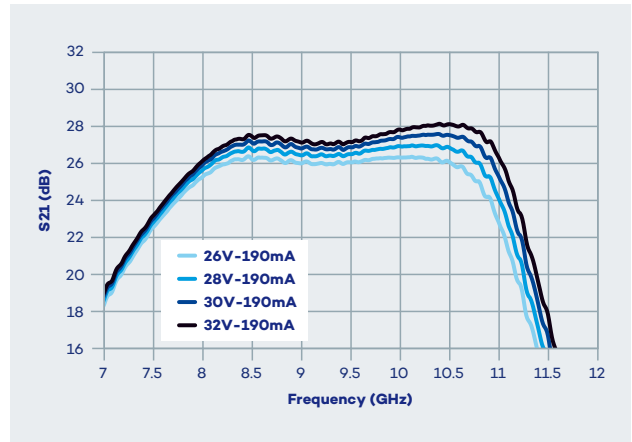

**Input Return Loss vs Frequency vs Temperature**

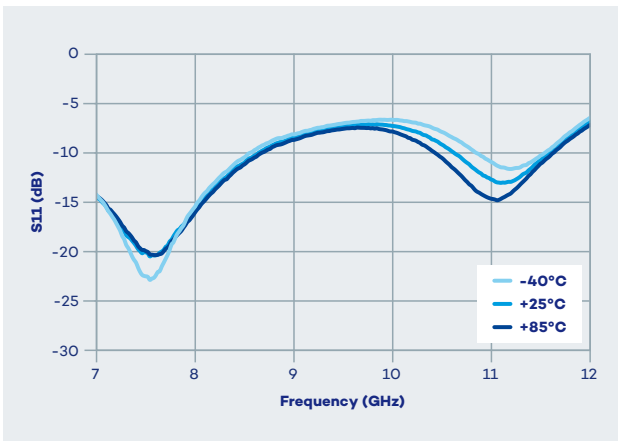

**Gain vs Frequency vs  $I_{BQ}$**

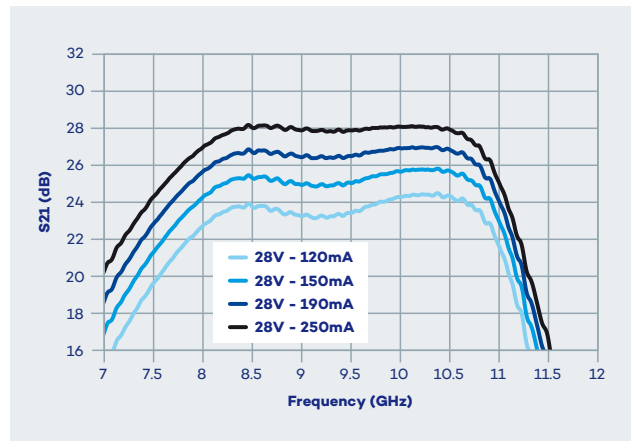

**Output Return Loss vs Frequency vs Temperature**

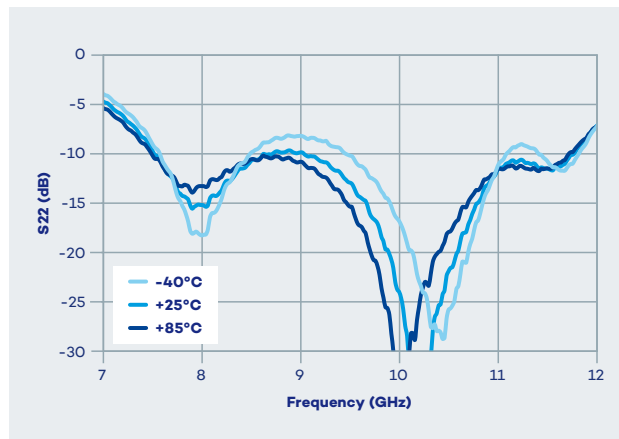

• **Typical Performance**  
(Large signal / Board Measurement)

Test conditions: unless otherwise specified

- Reference plane: component access
- $V_D = +28V$
- $I_{BQ} = 190mA$  ( $V_G = -2.35V$  Typ.)
- $P_{in} = +23dBm$
- Pulsed mode (pulse width:  $30\mu s$ , duty cycle: 10%)

**Output Power vs Frequency vs Temperature**

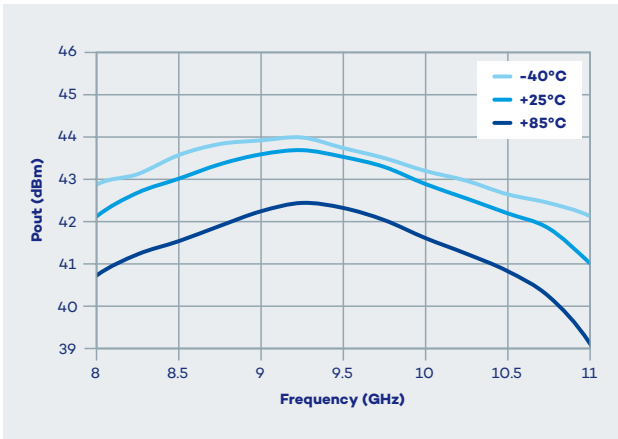

**Output Power vs Input Power vs Temperature**

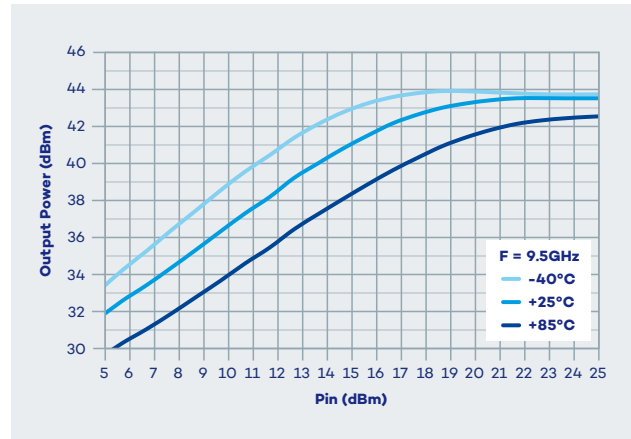

**Power Gain vs Frequency vs Temperature**

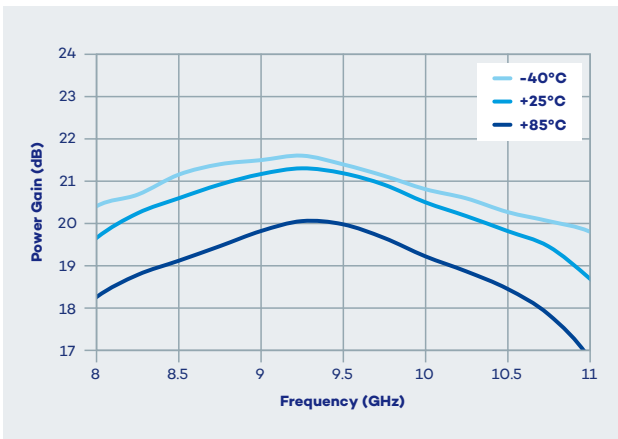

**Gain vs Input Power vs Temperature**

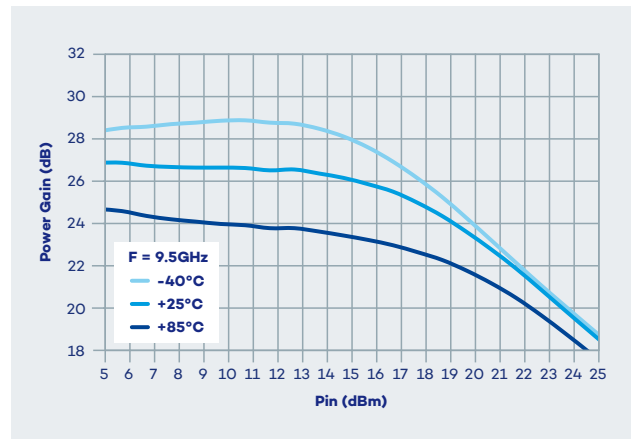

**Drain Current vs Frequency vs Temperature**

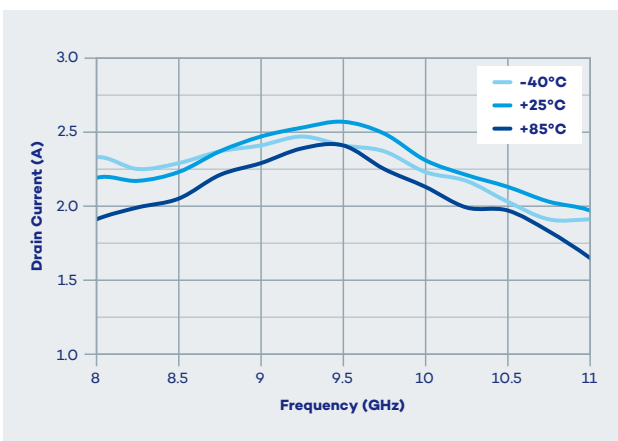

**PAE vs Frequency vs Temperature**

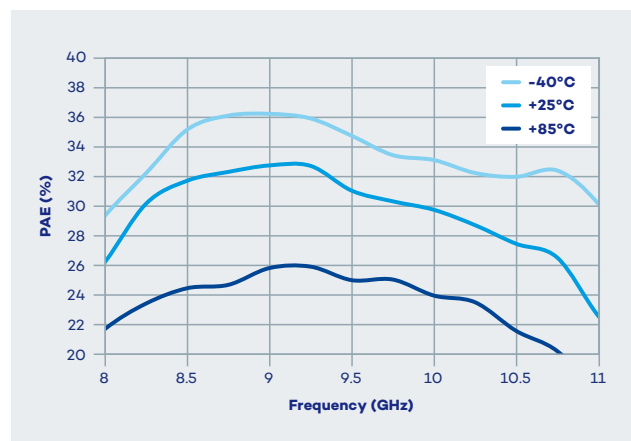

• **Typical Performance**  
(Large signal / Board Measurement)

Test conditions: unless otherwise specified

- Reference plane: component access
- $V_D = +28V$
- $I_{BQ} = 190mA$  ( $V_G = -2.35V$  Typ.)
- $T_{amb} = +25^\circ C$
- Pulsed mode (pulse width:  $30\mu s$ , duty cycle: 10%)

**Output Power vs Input Power vs Frequency**

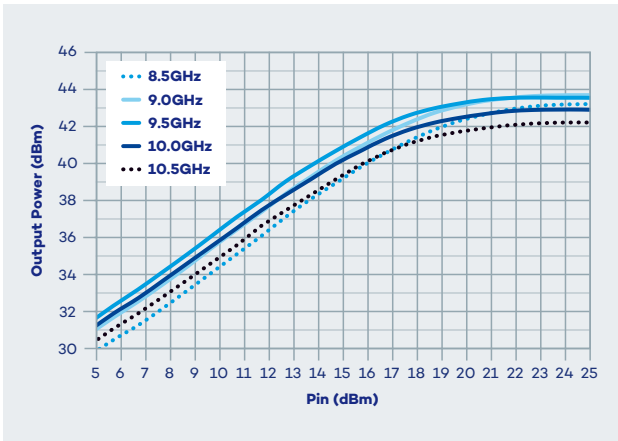

**Gain vs Input Power vs Frequency**

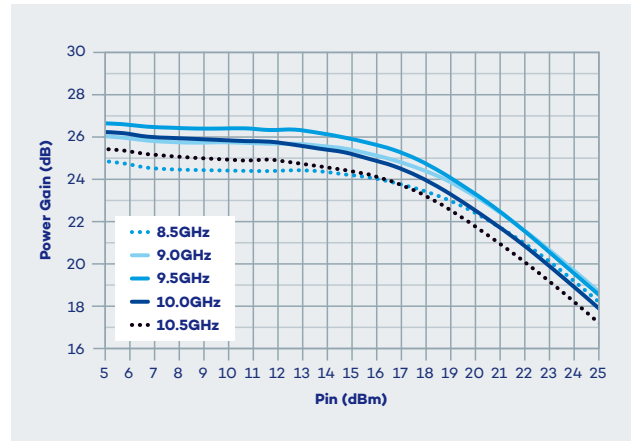

**Drain Current vs Input Power vs Frequency**

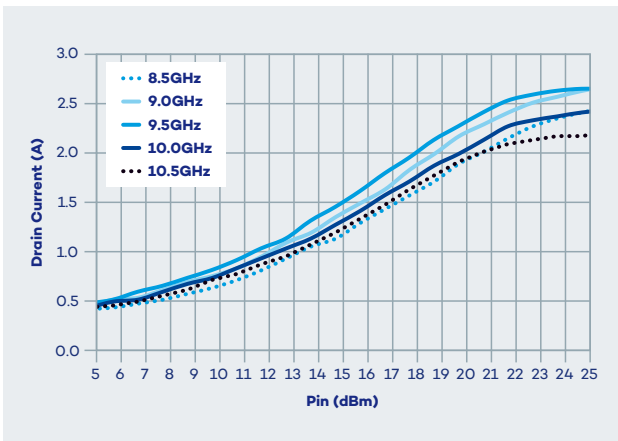

**PAE vs Input Power vs Frequency**

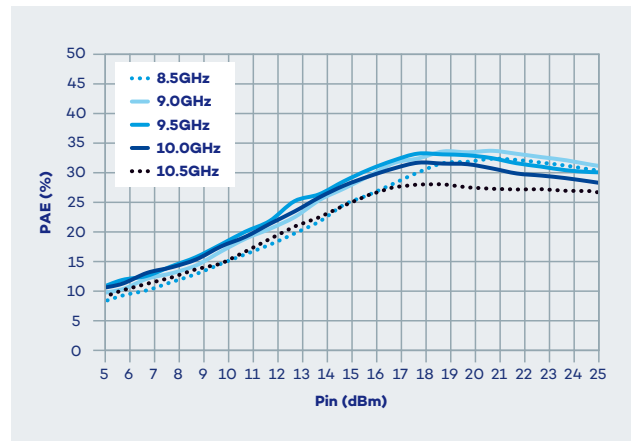

**Output Power vs Frequency vs  $V_D$**

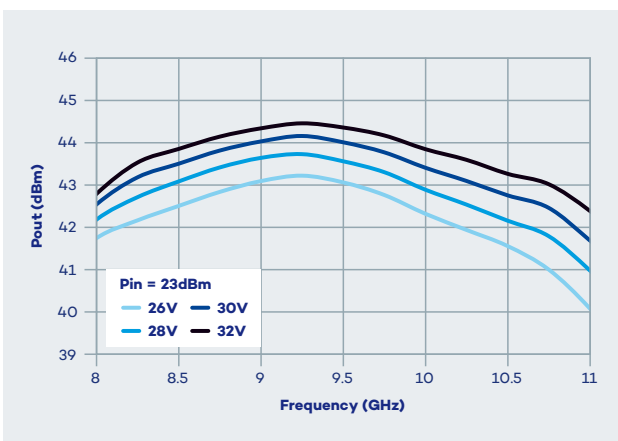

**PAE vs Frequency vs  $V_D$**

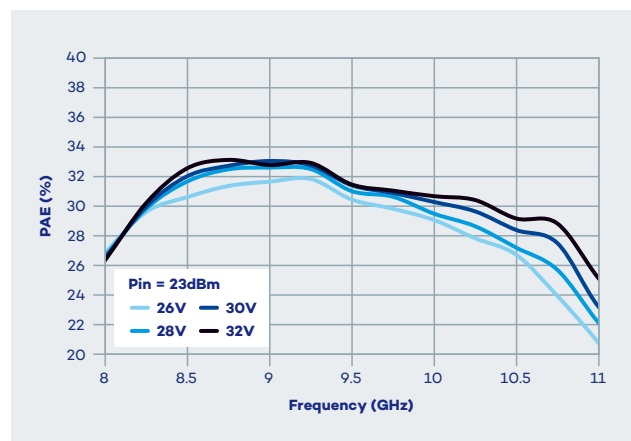

• **Typical Performance**  
(Large signal / Board Measurement)

Test conditions: unless otherwise specified

- Reference plane: component access
- $V_D = +28V$
- $T_{amb} = +25^\circ C$
- Pulsed mode (pulse width: 30 $\mu s$ , duty cycle: 10%)

**Output Power vs Input Power vs  $I_{DQ}$**

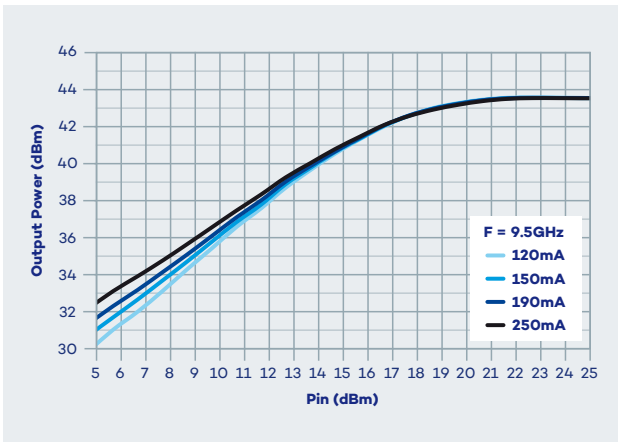

**Gain vs Input Power vs  $I_{DQ}$**

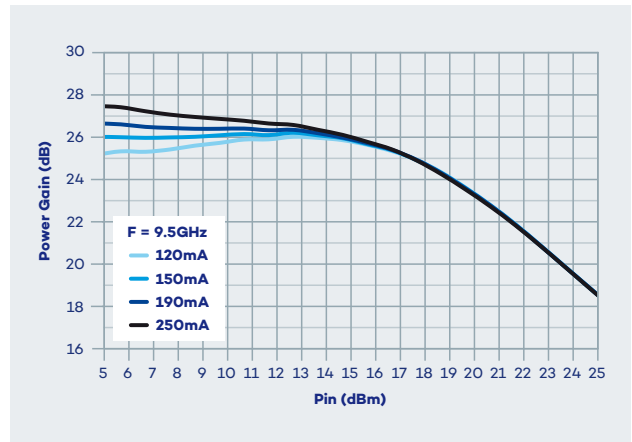

**Drain Current vs Input Power vs  $I_{DQ}$**

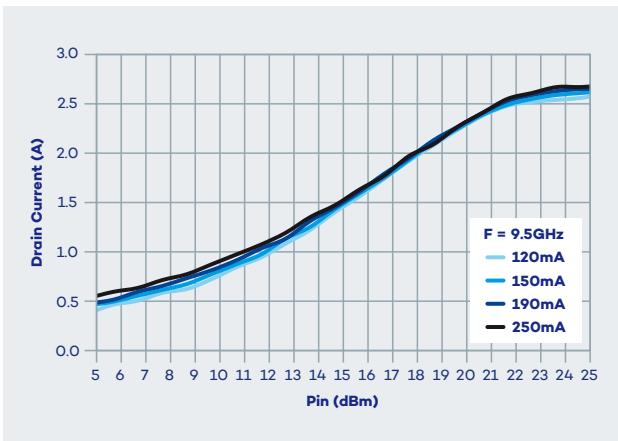

**Drain Current vs Frequency vs  $I_{DQ}$**

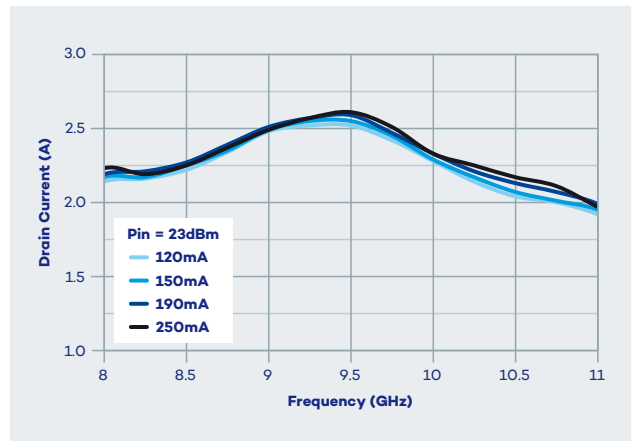

**PAE vs Input Power vs  $I_{DQ}$**

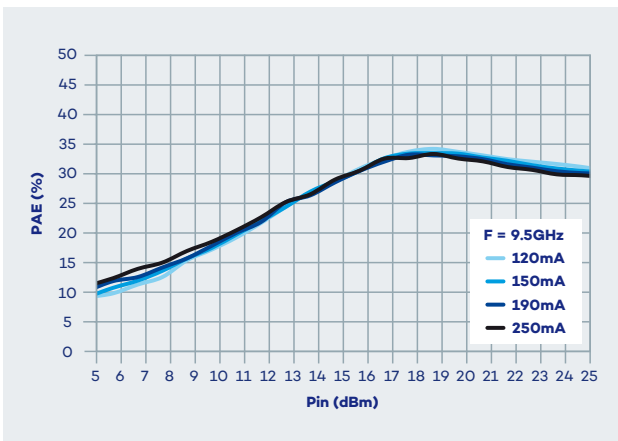

**PAE vs Frequency vs  $I_{DQ}$**

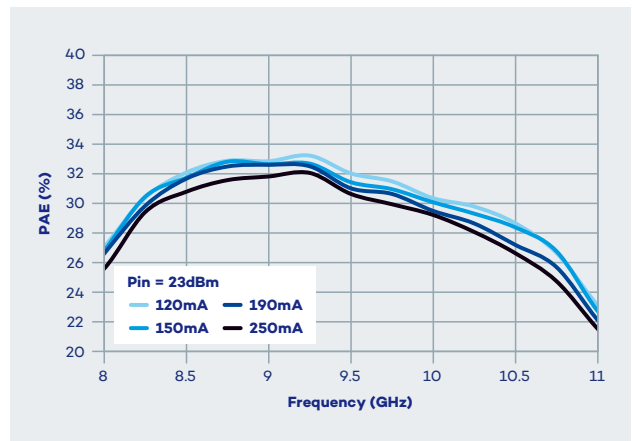

• **Application circuit**

- C1 to C5 = 1µF (50V/0603)
- C6, C7 = 100µF (16V/0805)

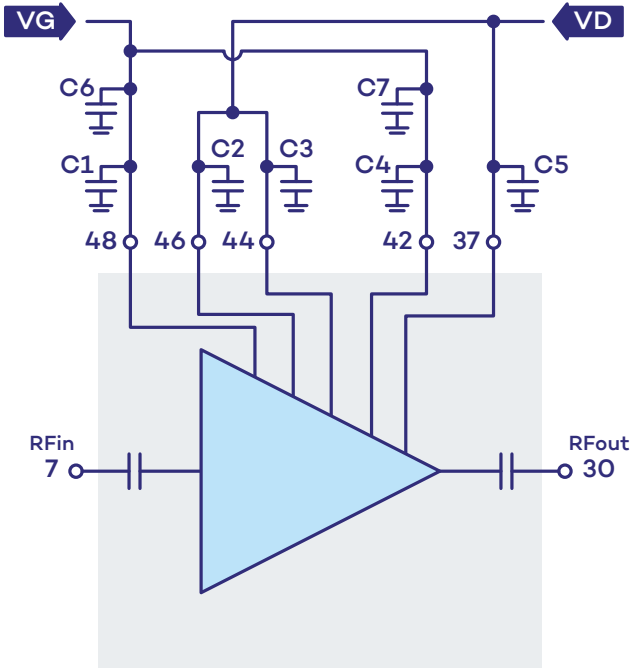

• **Bias-up procedure**

1. Apply  $V_G = -3V$
2. Apply  $V_D = +28V$
3. Adjust  $V_G$  to obtain the specified  $I_{BQ} = 190\text{ mA}$  ( $V_G = -2.35V$  Typ.)
4. Apply RF signal in pulsed mode

• **Bias-down procedure**

1. Turn off RF signal
2. Reduce  $V_G = -3V$
3. Apply  $V_D = 0V$
4. Turn off power supply

• **Pin description**

Pin number	Name	Description	Electrical interface
7	RF in	Amplifier input, this access is AC coupled and internally matched to 50 Ohms	
42, 48	$V_{G1, 2}, V_{G3}$	HPA Gate biasing input accesses	
37, 44, 46	$V_{D1}, V_{D2}, V_{D3}$	HPA Drain biasing input accesses	
30	RF out	Amplifier output, this access is AC coupled and internally matched to 50 Ohms	
Exposed Pad	Gnd	Die must be connected to RF and DC Ground	

• Mechanical drawing

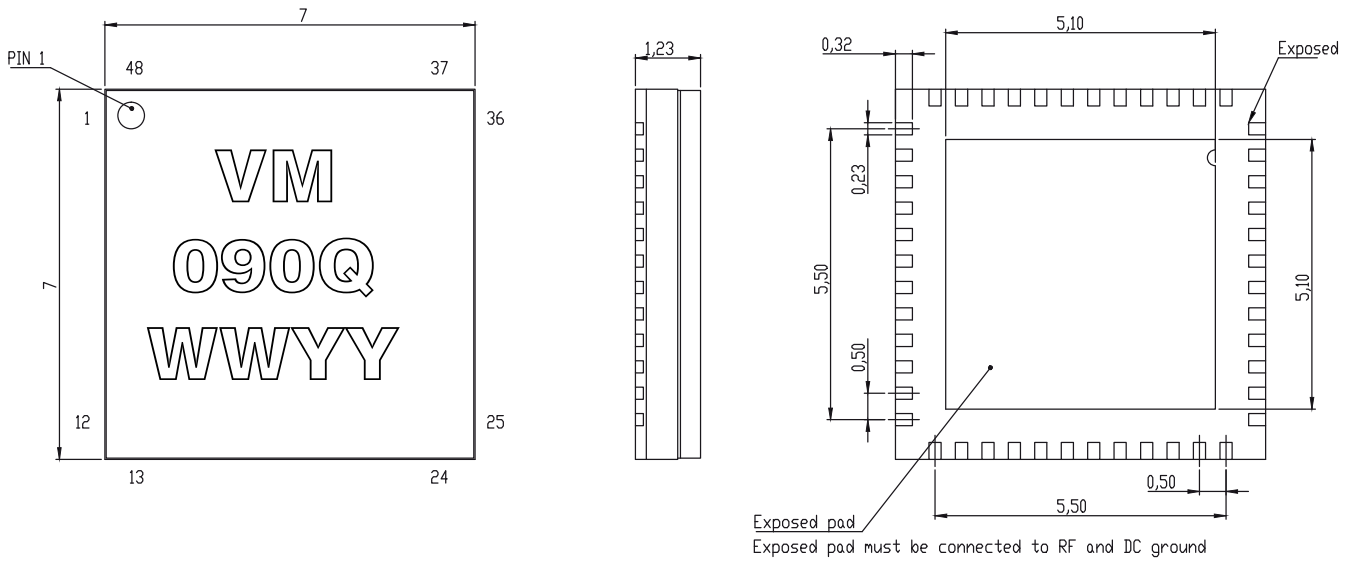

• Evaluation Board (EVB) Layout Assembly

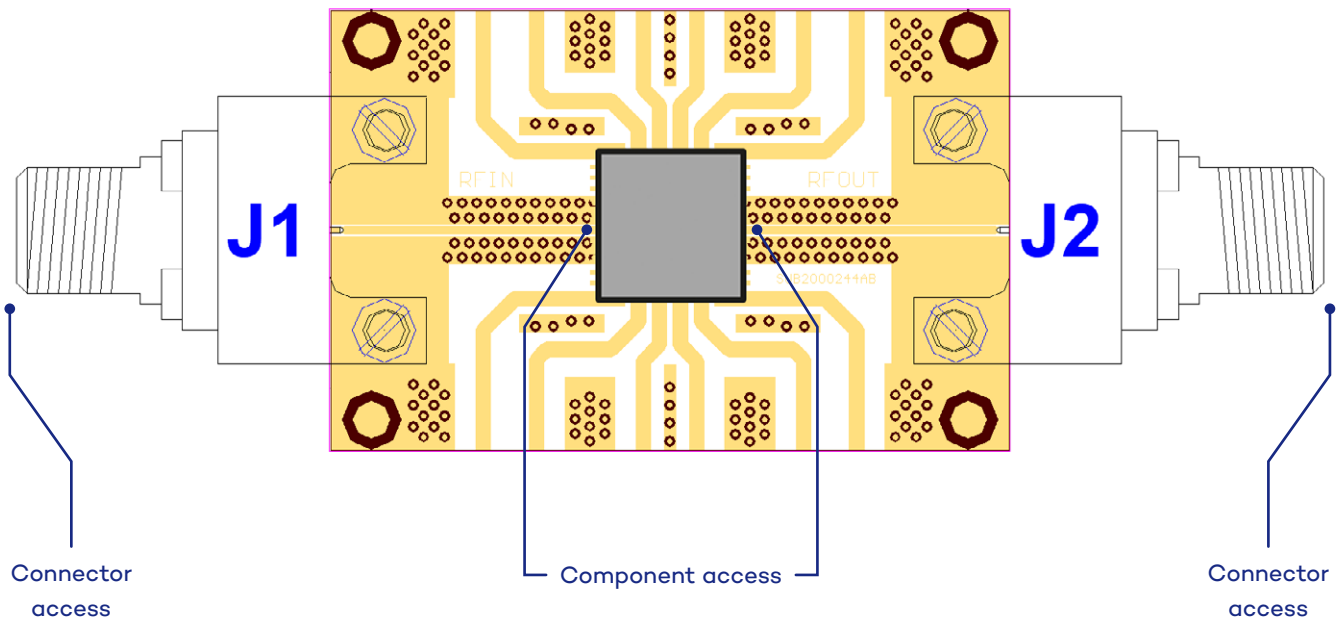



## • Ordering information

Product Code	Parameter
VM090Q	8.5 to 10GHz - 20W GaN Power Amplifier QFN 7mmx7mm 48 leads

## • Associated Material

- Evaluation Board
- Mechanical files (DXF)

## • Product Compliance Information

### Solderability

Solder Stencil thickness: 127µm

Solder: SAC 305 (ROHS)

Temperature profile example: maximum recommended reflow profile (leadfree)

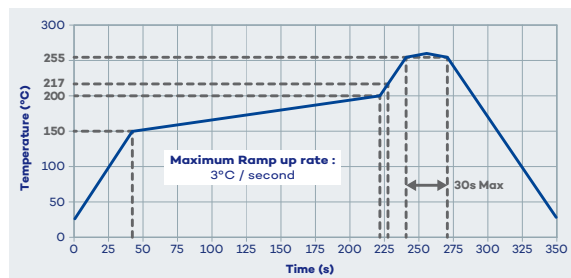

### ESD Sensitivity Rating

Test: Human Body Model (HBM)

Std: JEDEC Standard JESD22-A114



### RoHS-Compliance

This part is compliant with EU 2011/65/EU RoHS directive (Restrictions on the Use of Certain Hazardous Substances in Electrical and Electronic Equipment).

### Other attributes

- Lead Free
- Halogen Free (Chlorine, Bromine)
- Antimony Free
- TBBP-A (C15H12Br4O2) Free
- PFOS Free
- SVHC Free

## • Contact information

For the latest specifications, additional product information, worldwide sales and distribution locations, and information about Vectrawave.

### vectrawave.com

+33 (0)2 57 63 00 20

contact\_sales@vectrawave.com

### Vectrawave SA

5, rue de Louis de Broglie  
22300 Lannion  
France

Informations contained in this document, are considered to be accurate and reliable. However, no responsibility is assumed by Vectrawave for the consequence of its use, nor for any infringement of patents or other rights of third parties that may result from this use. Products are not authorized for use in life support devices without prior written approval from Vectrawave. Specifications are subject to changewithout notice